



GJS-8013

Features

- Advanced internal structure design
- Easy and fast to fix fiber cable
- Fiber suffers no attenuation
- The closure is spacious enough for winding and storing fibers
- Fiber Optic Splice Trays(FOSTs) are design in SLIDE-IN-LOCK and its opening angle is about 90°
- The curved diameter meets with international standard
- Easy and fast to increase and reduce FOSTs
- Innovative elastic intergrated seal fitting

Applications

- ◆ Suitable for bunchy & ribbon fibers
- ◆ Aerial, underground, wall-mounting, hand hole-mounting
Pole-mounting and duct-mounting

Structural Drawing

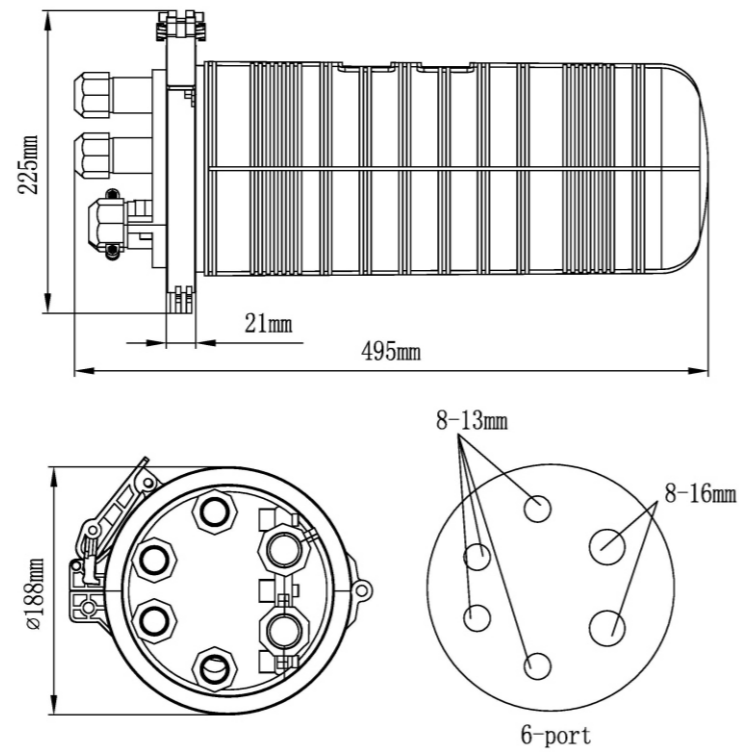

Ordering Information

Optical Splice Trays

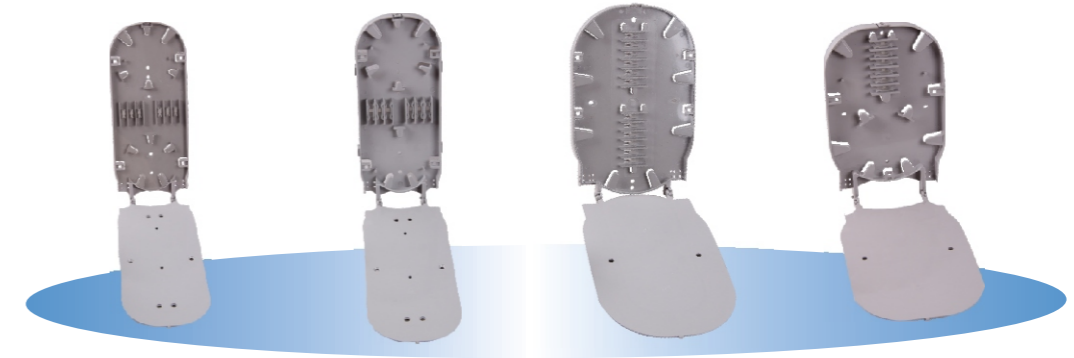



#031 234X96X7.5mm #032 234X100X11mm #027 215X140X11mm #026 205X96X11mm

Type	Fibers/Tray	Max. Capacity	Tray#	Suitable Cable Dia. allowed(mm)
GJS-8013 I(Bunchy)	12F	120	031	1 oval ports:16mm 4 round ports:13mm
GJS-8013 II(Bunchy)	12-24F	144	032	
GJS-8013 III(Bunchy)	24-48F	192	027	
GJS-8013 IV(Ribbon)	72F	216	026	





Accessories



Standard Accessories:

No.	Name	Quantity	
1	Seal tape	1 roll	
2	Abrasive cloth	1 pc	
3	Nylon tie	1 set	
4	Earthing wire	1 pc	

No.	Name	Quantity	
5	Labeling paper	1 pc	
6	Heat shrinkable protective sleeve	1 bag	
7	Desiccant	2 bags	
8	Special wrench	3 pcs	

Optional Accessories:

No.	Name	Quantity	
1	Pressure testing valve	1 pc	
2	Earthing deriving device	1 pc	
3	Buffer tube for bunchy fiber	1 roll	
4	Buffer tube for ribbon tube	1 roll	

No.	Name	Quantity	
5	Aerial mountingbracket	1 set	
6	Pole mountingbracket	1 set	
7	Wall mountingbracket	1 set	